

BIM-09 - SERVIÇO - 2º PAVIMENTO

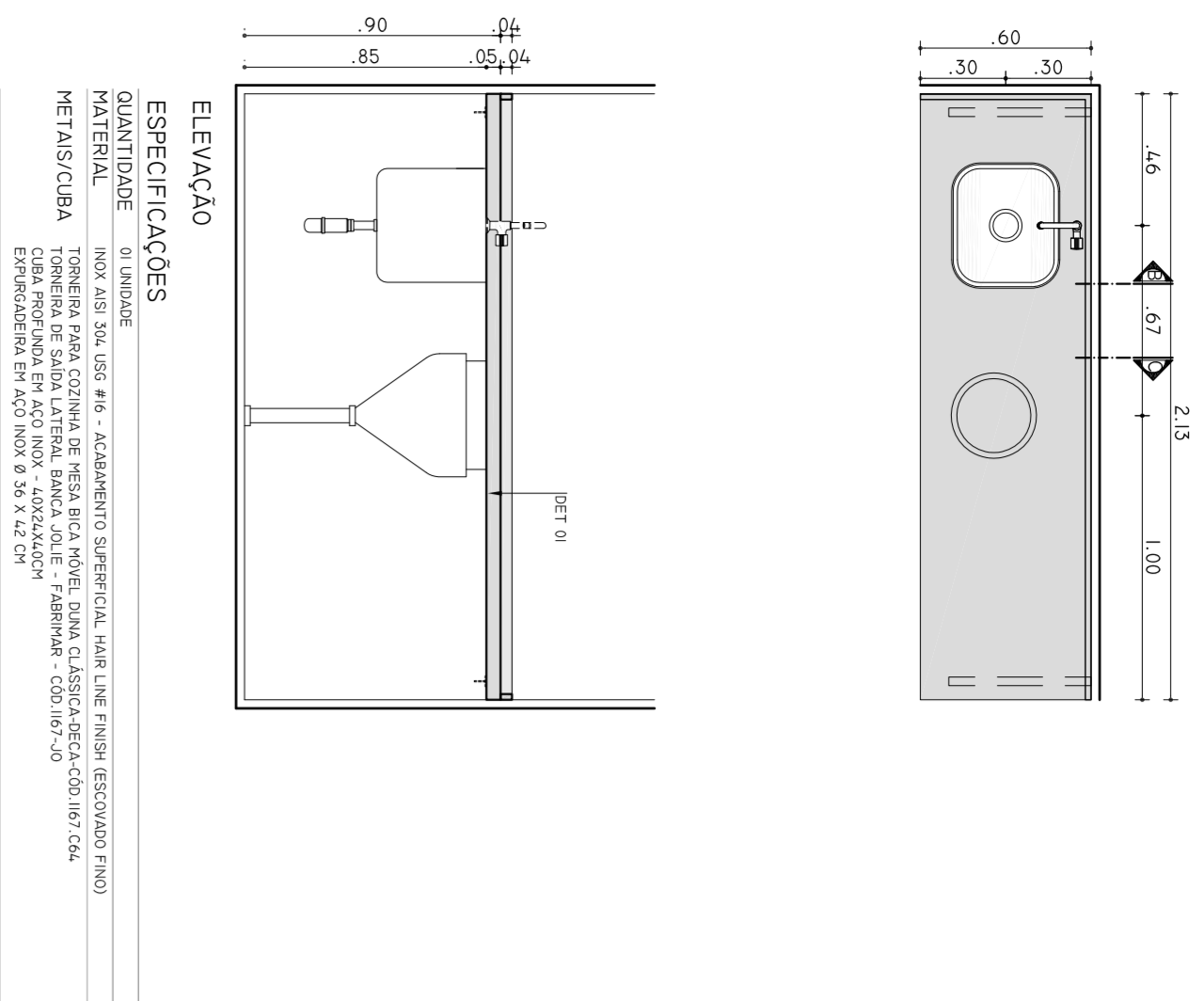

BIM-10 - SERVIÇO - 2º PAVIMENTO

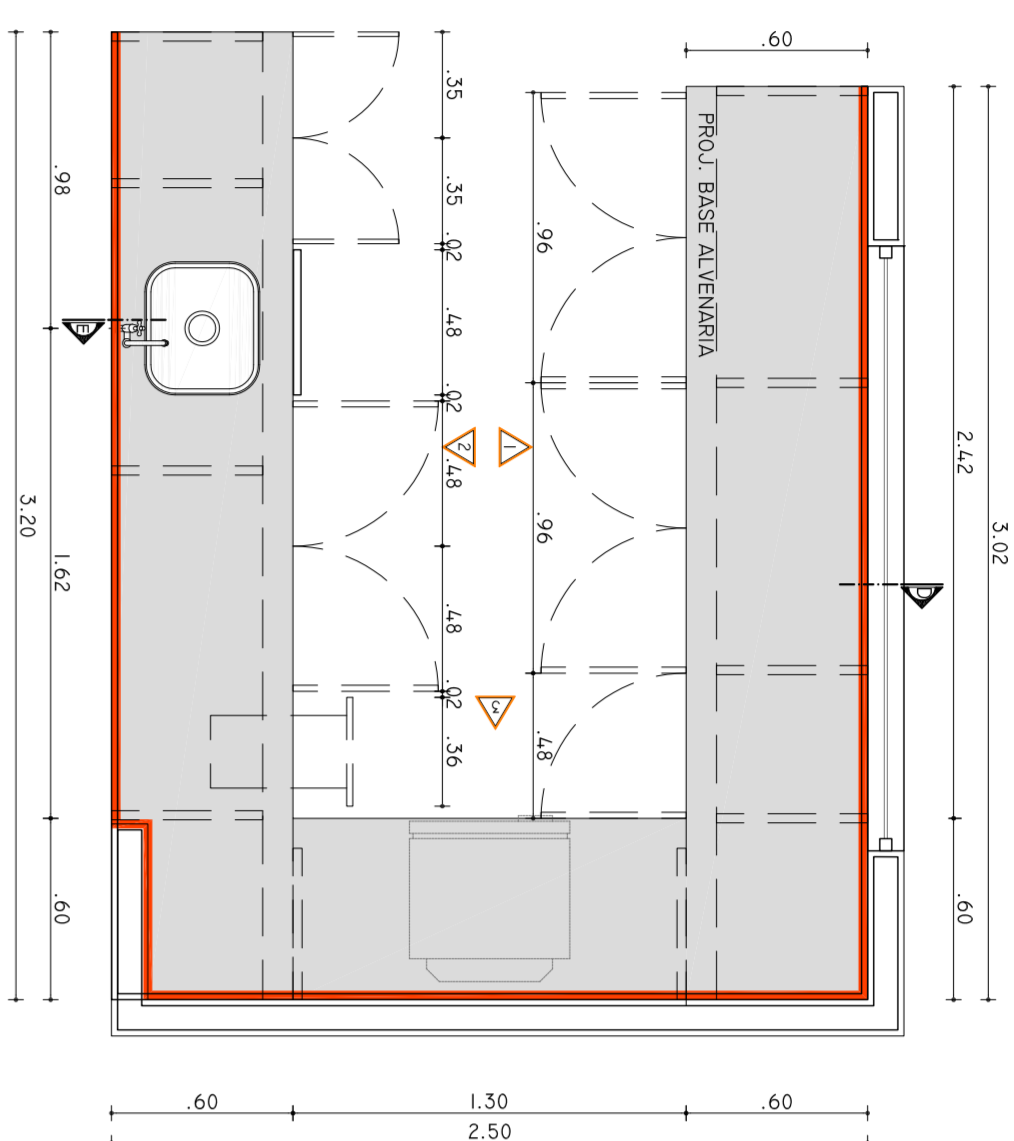

BIM-11 - SERVIÇO - 2º PAVIMENTO

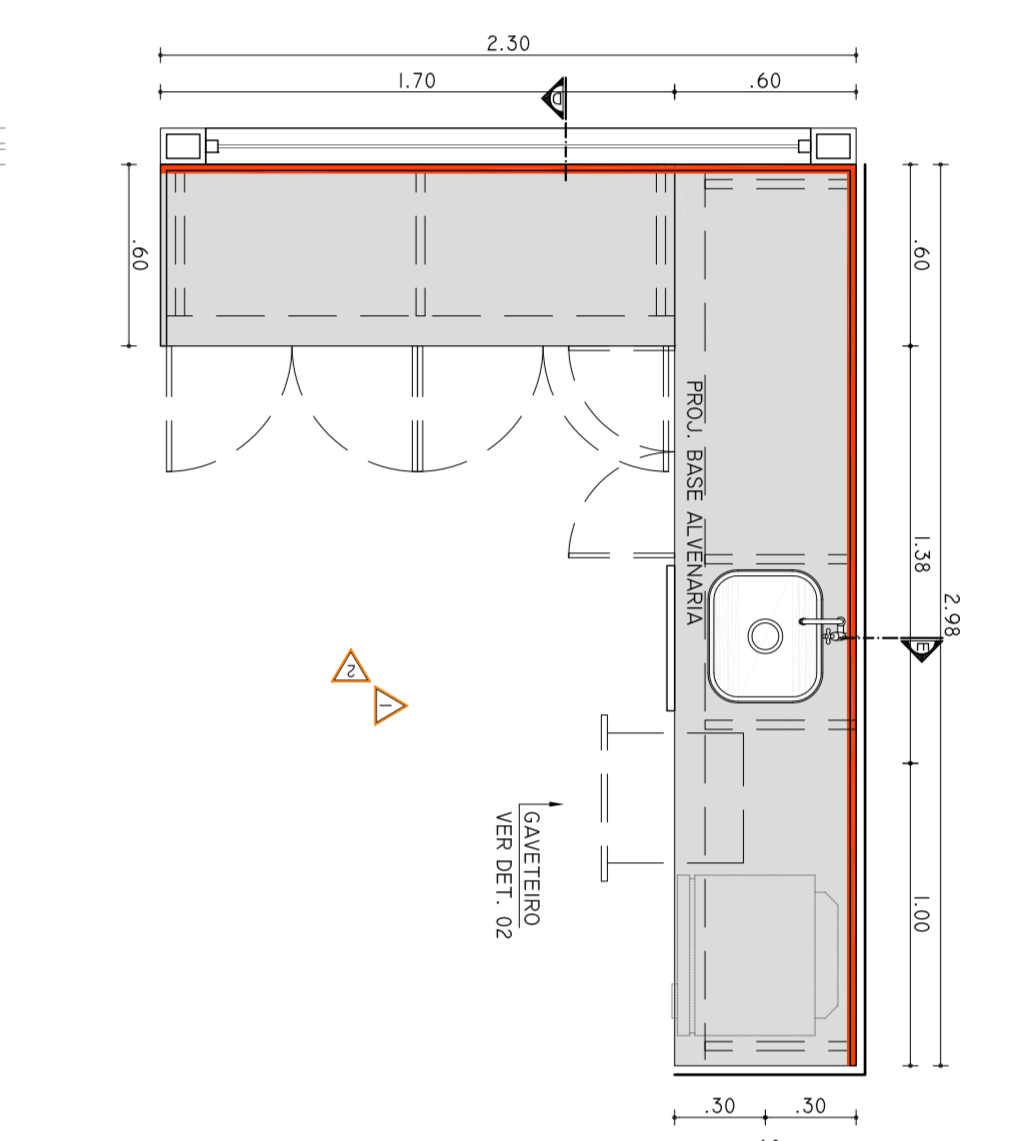

BIM-12 - SERVIÇO, POSTO DE ENFERMEIRA - 3º AO 8º PAVIMENTO

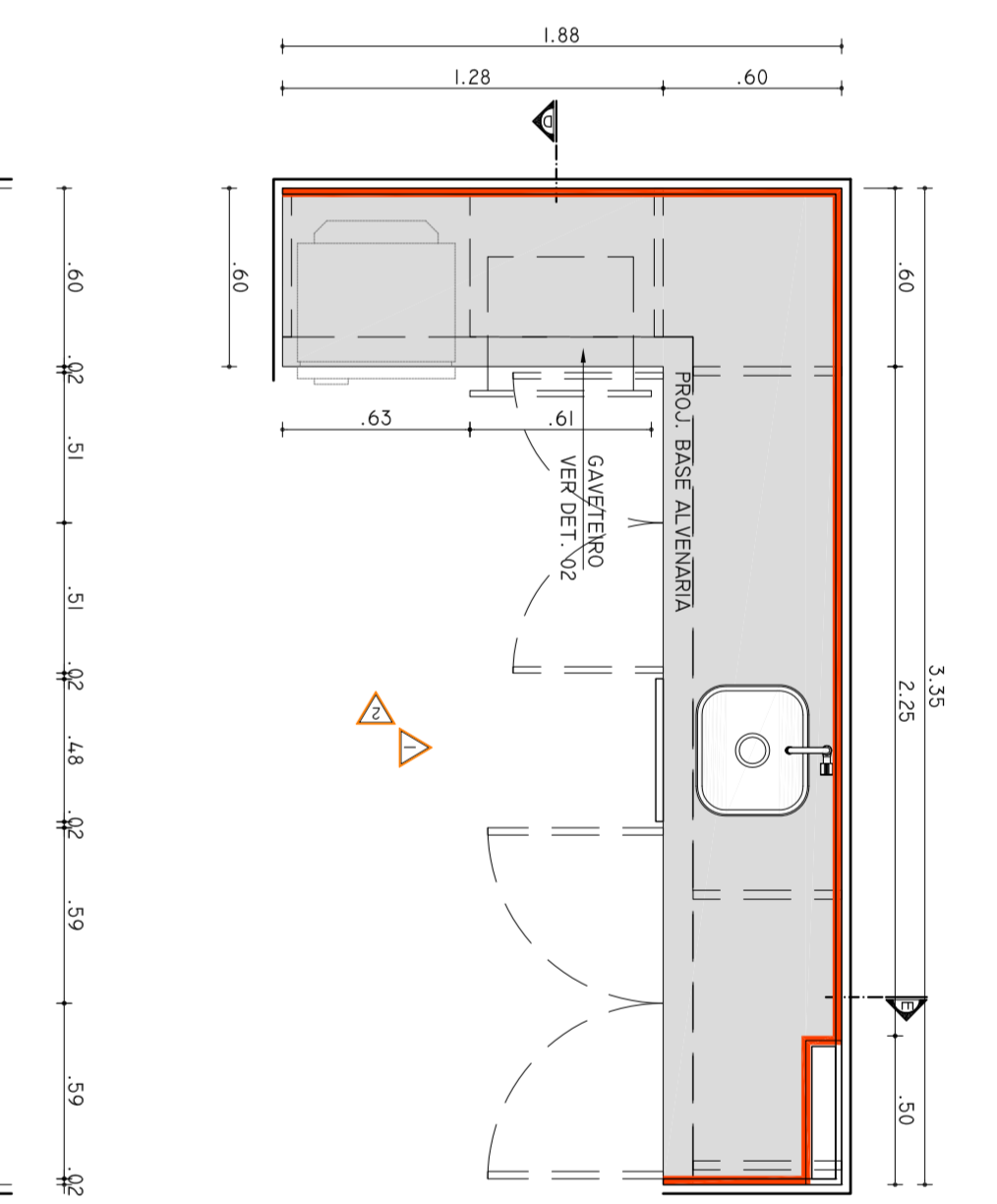

BIM-13 - SERVIÇO - 3º AO 8º PAVIMENTO

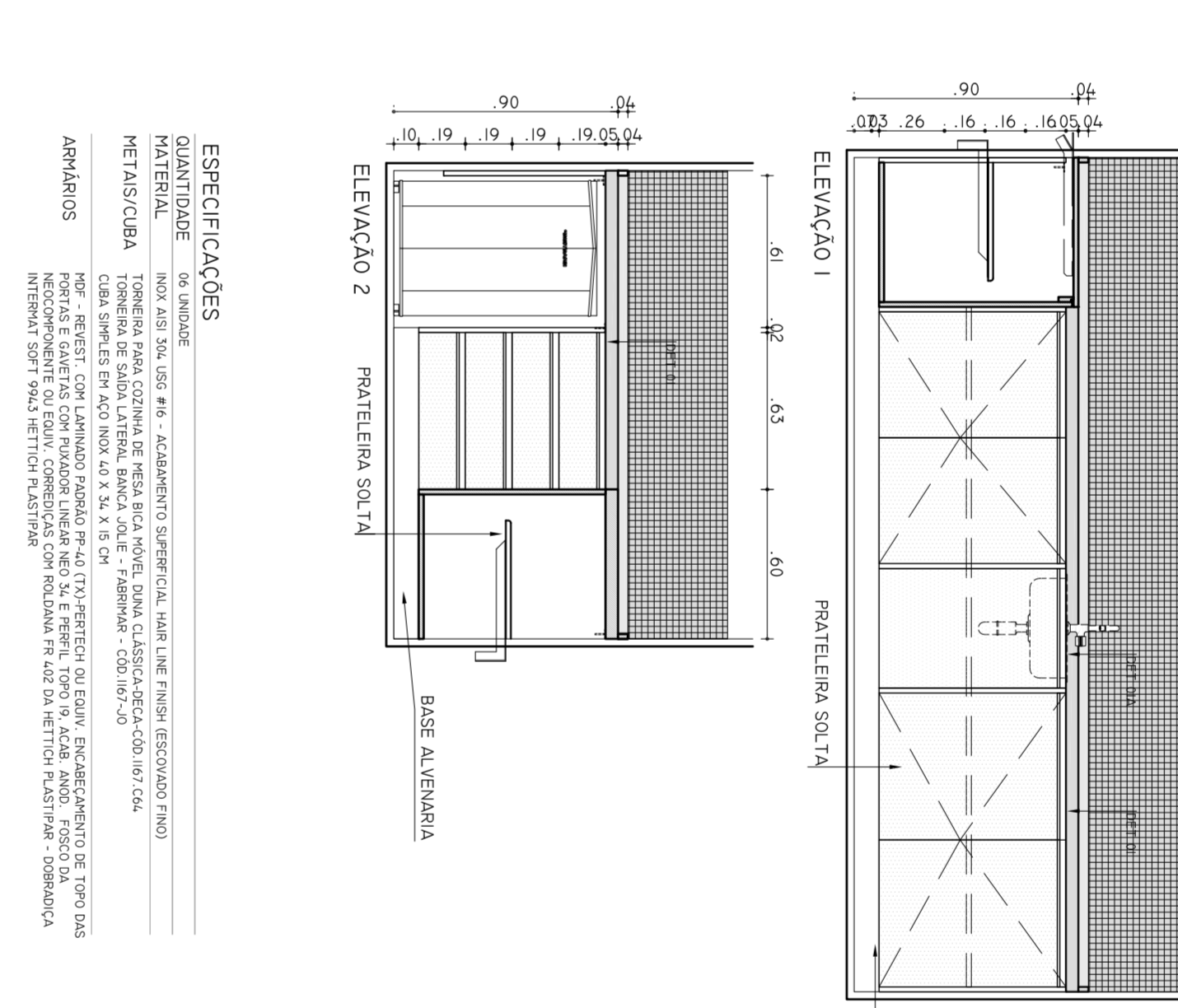
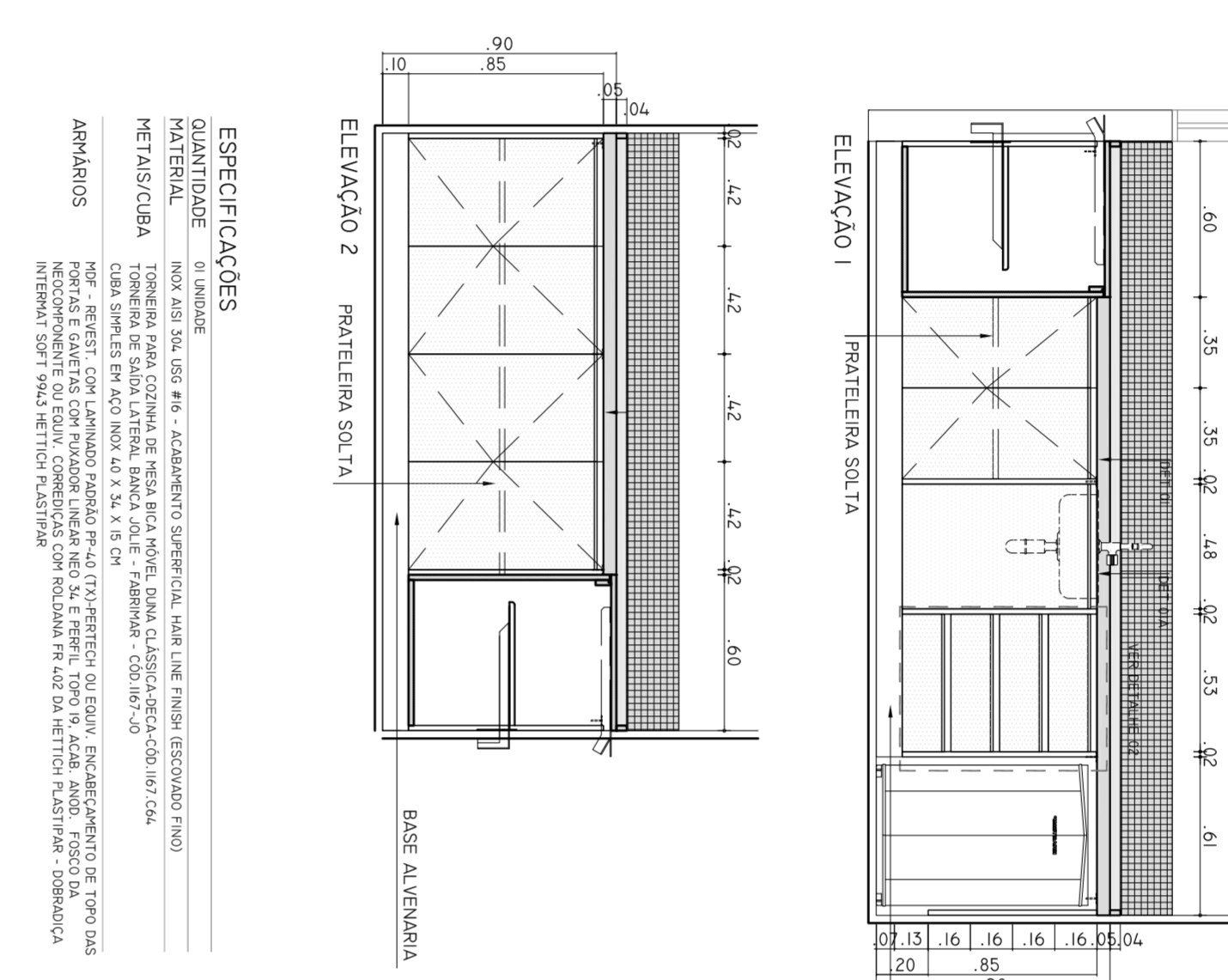
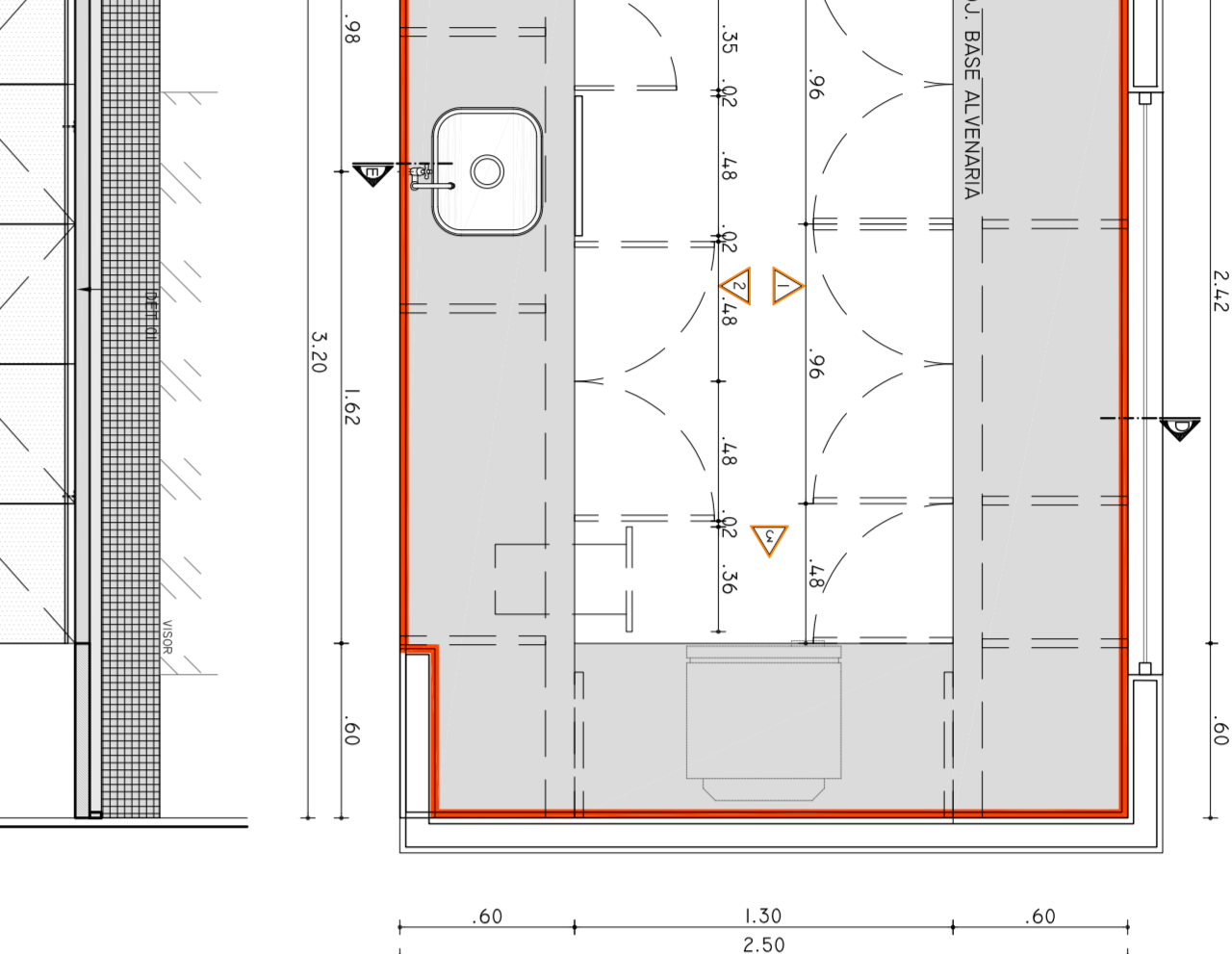
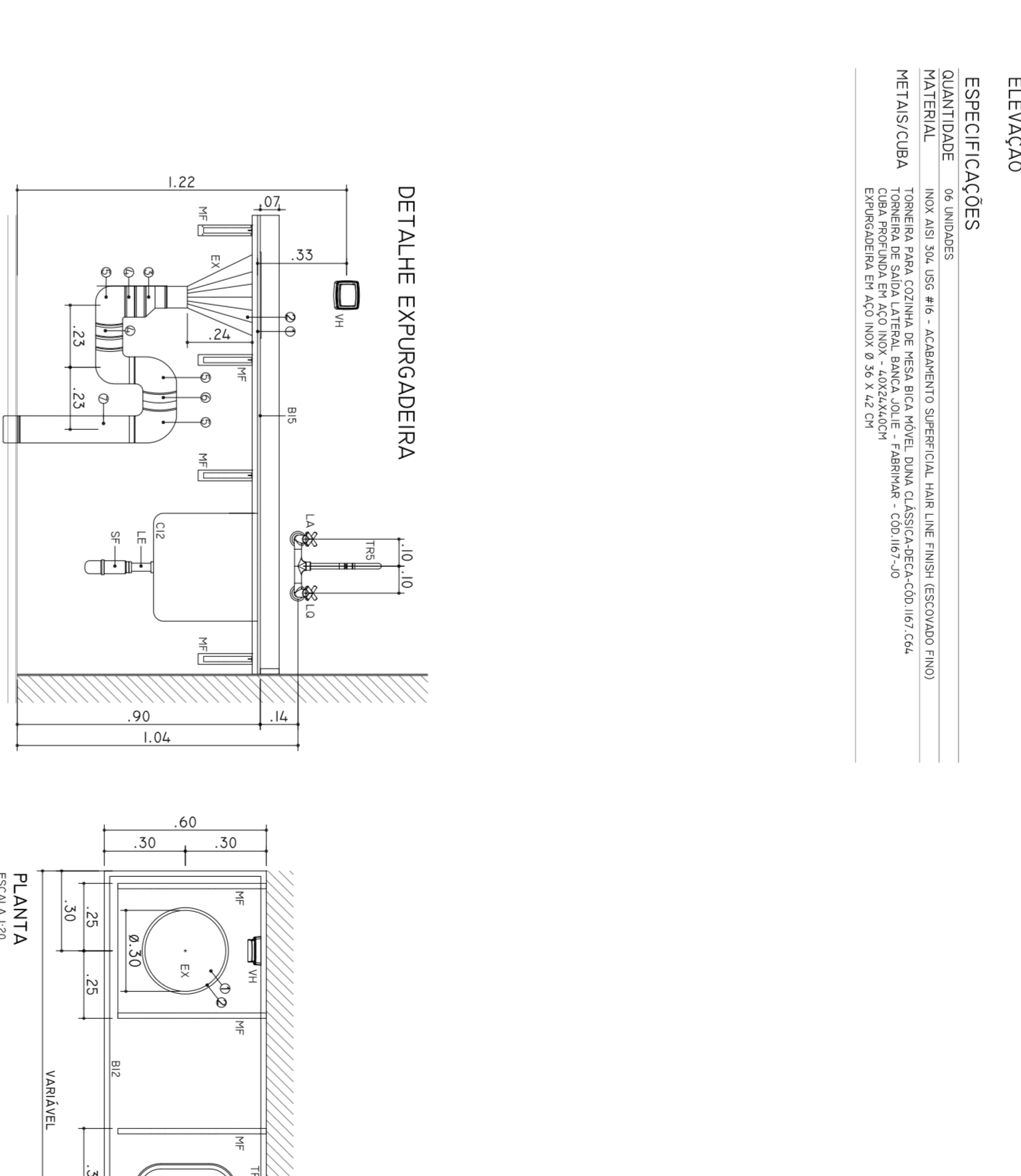
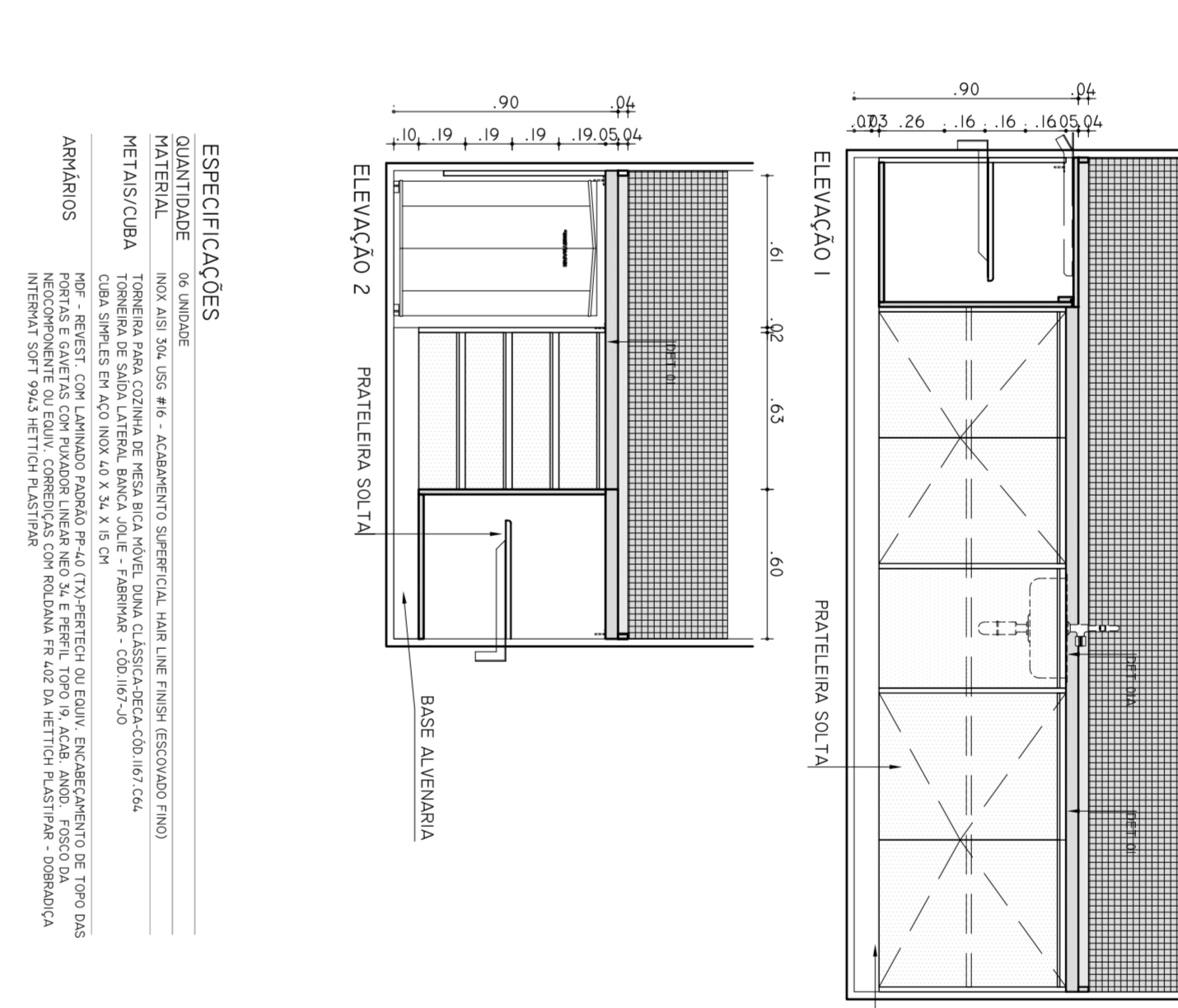
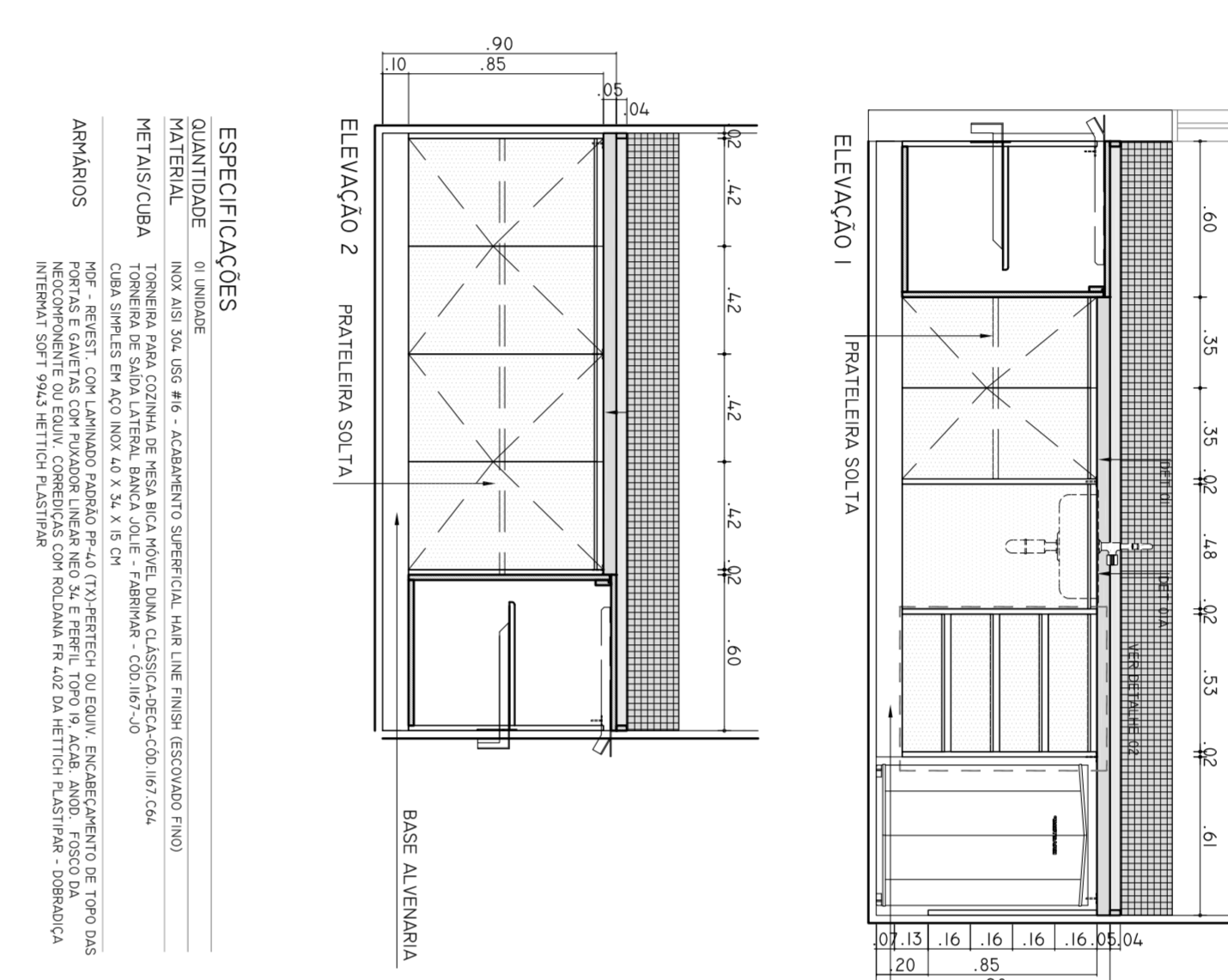
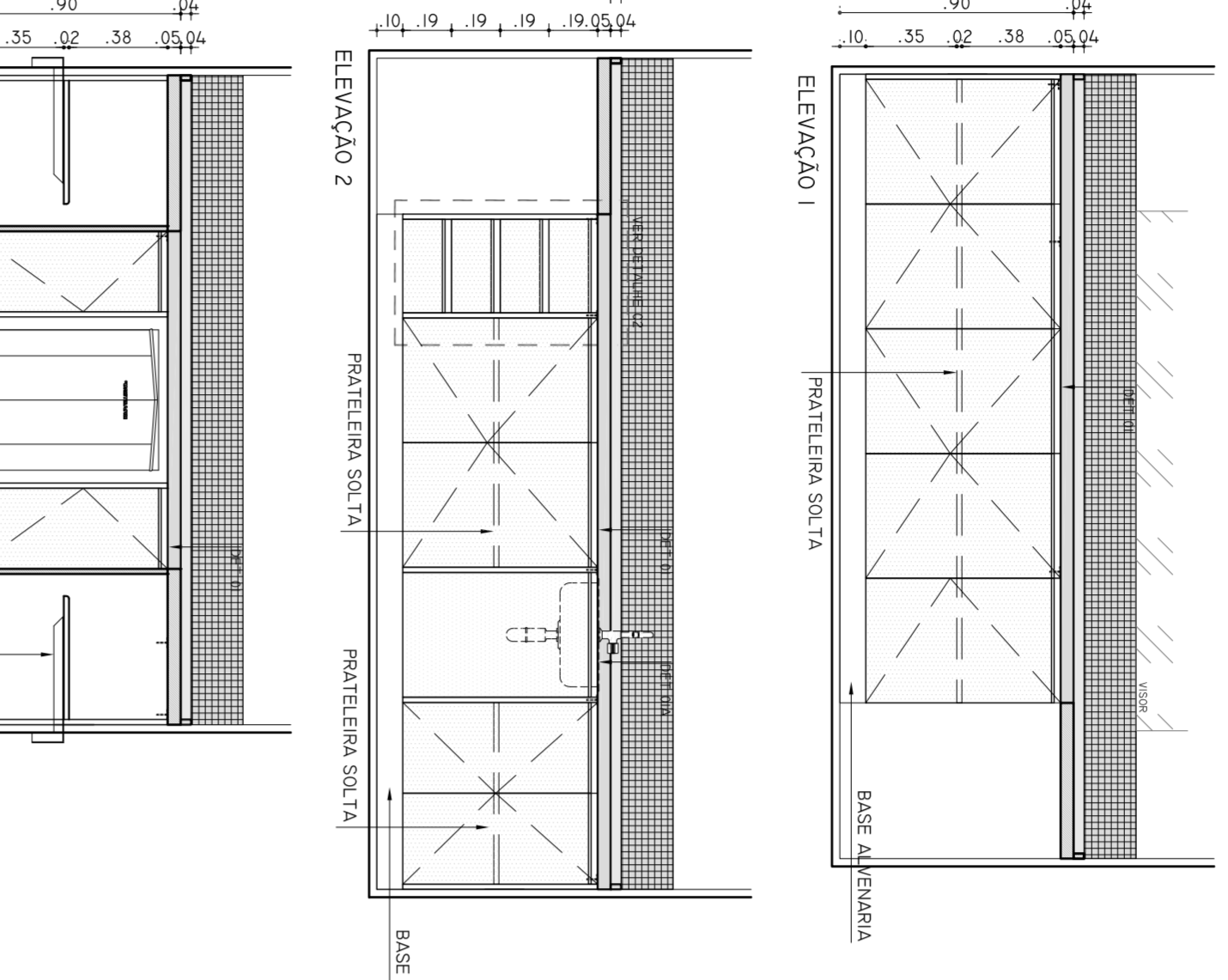
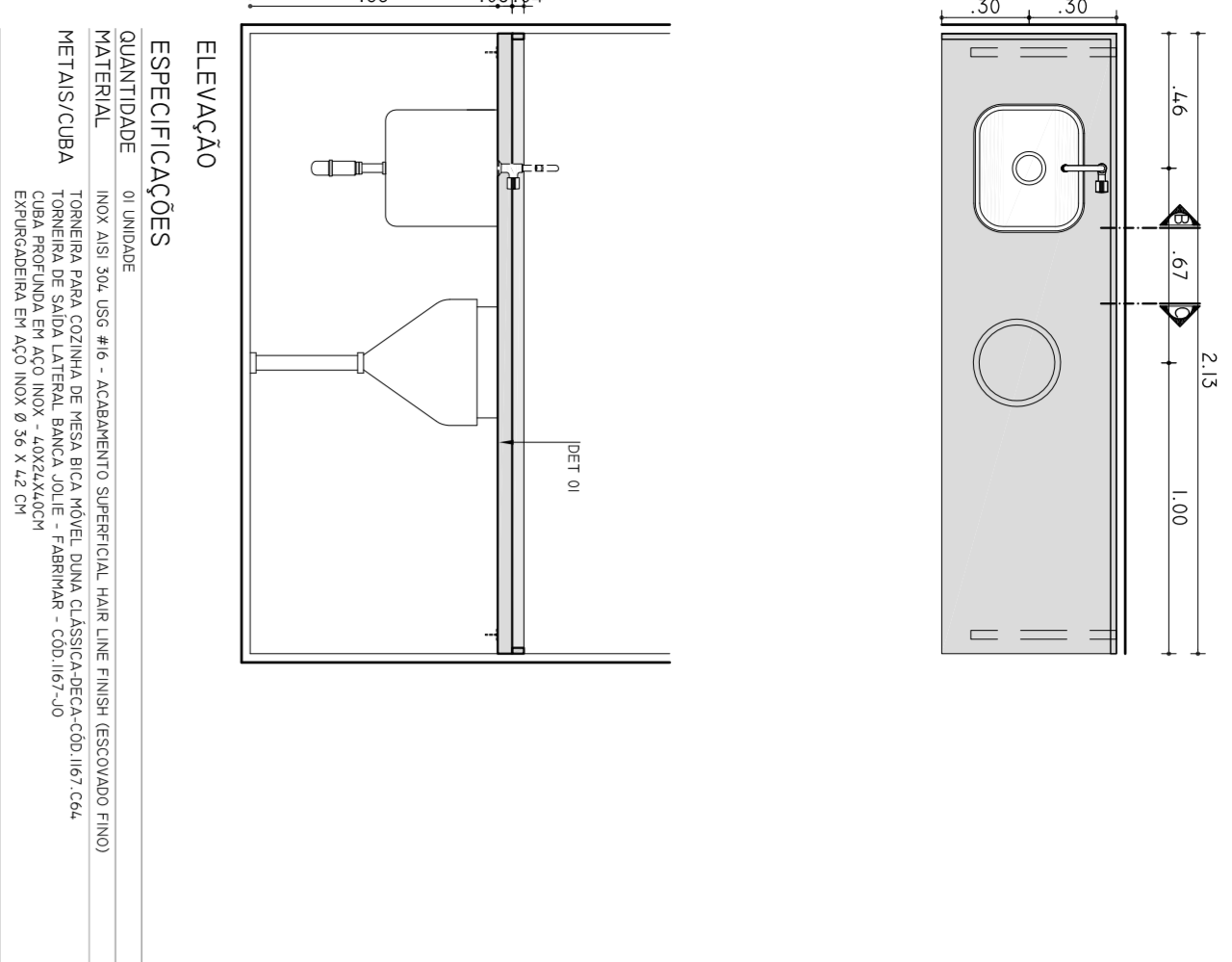
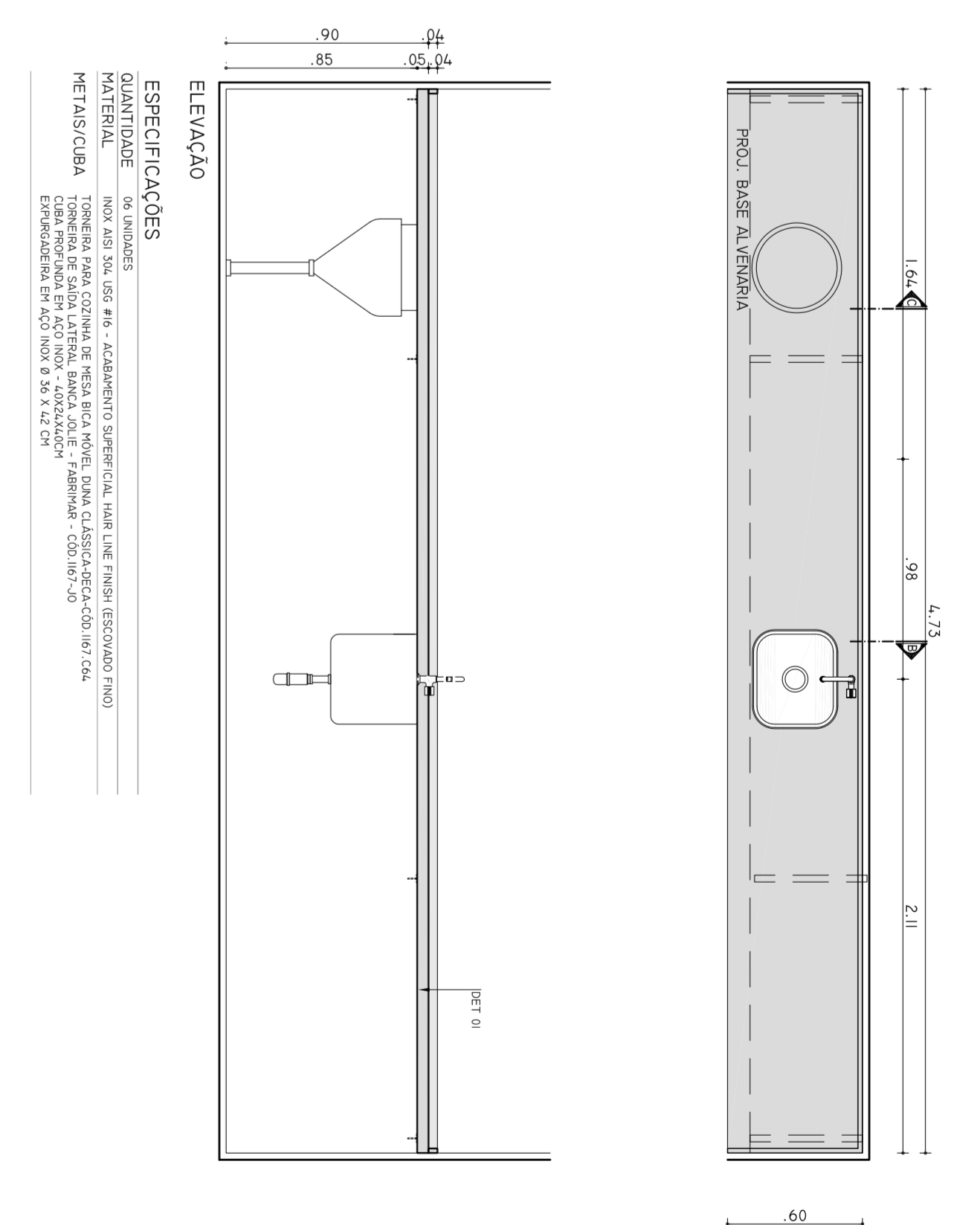

CORTE A - BANDEJA DE INOX COM CABA RASA (SIMPLES)

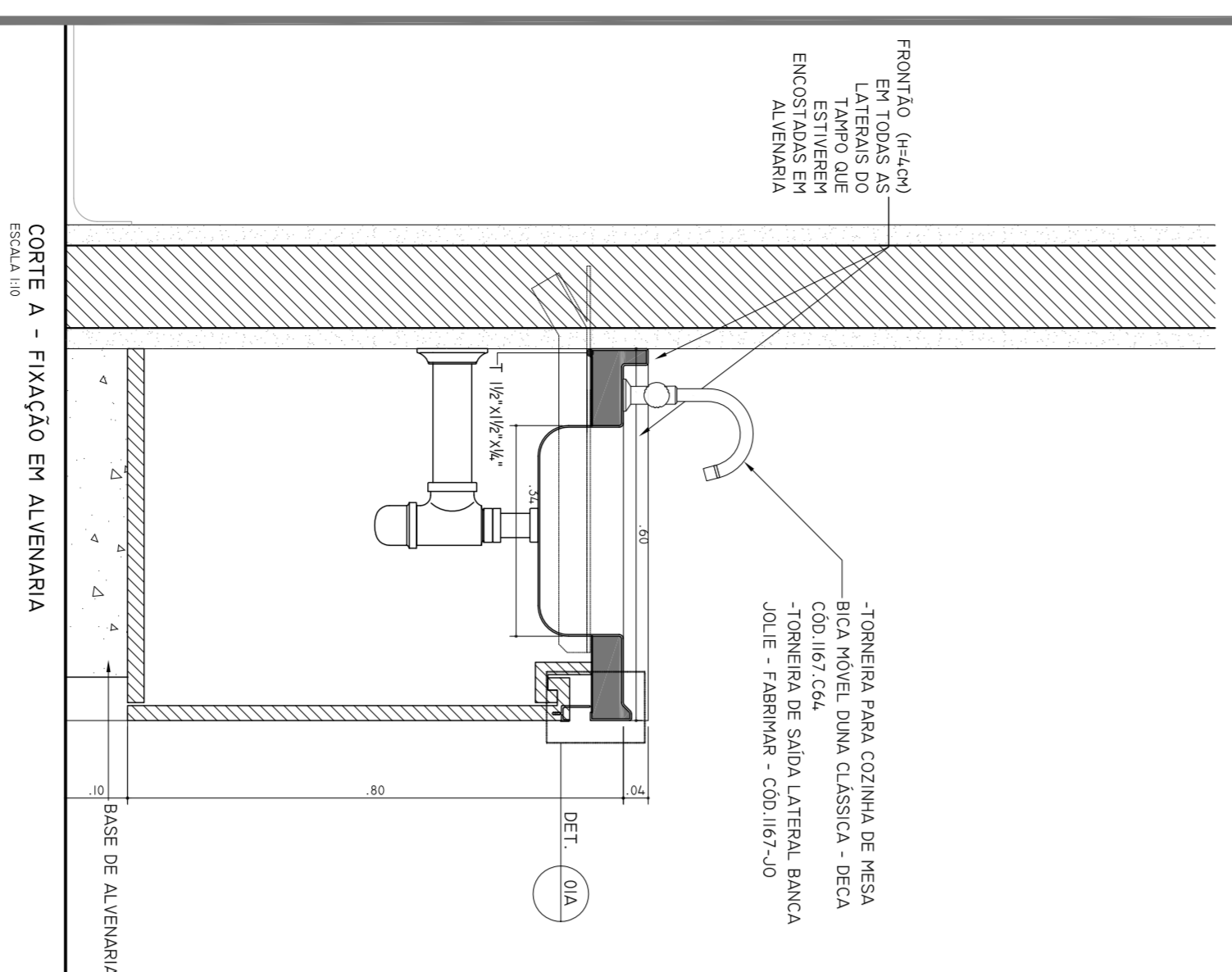

CORTE B - BANDEJA DE INOX COM CABA PROFUNDA (SIMPLES)

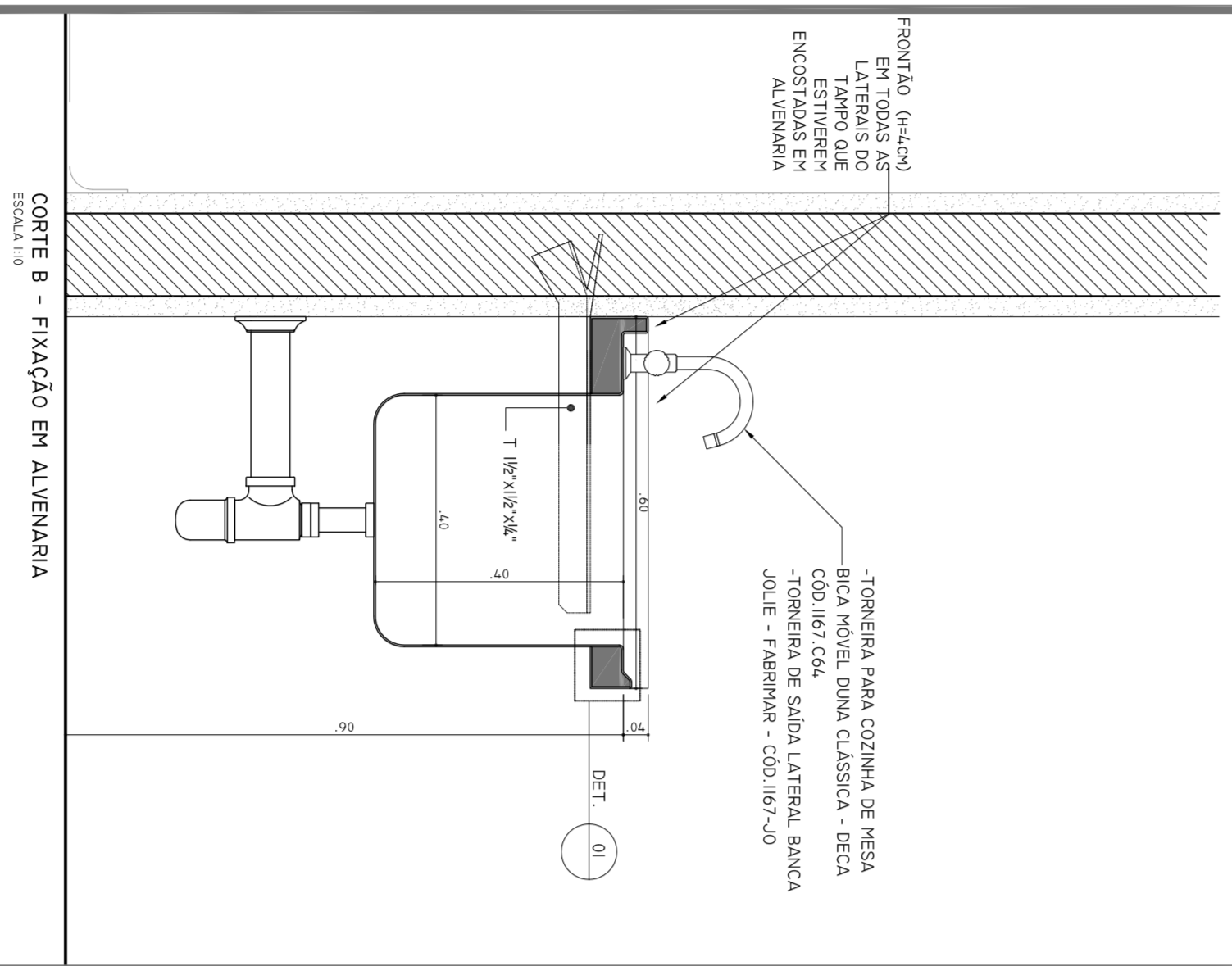

CORTE C - BANDEJA DE INOX COM EXPANSORA

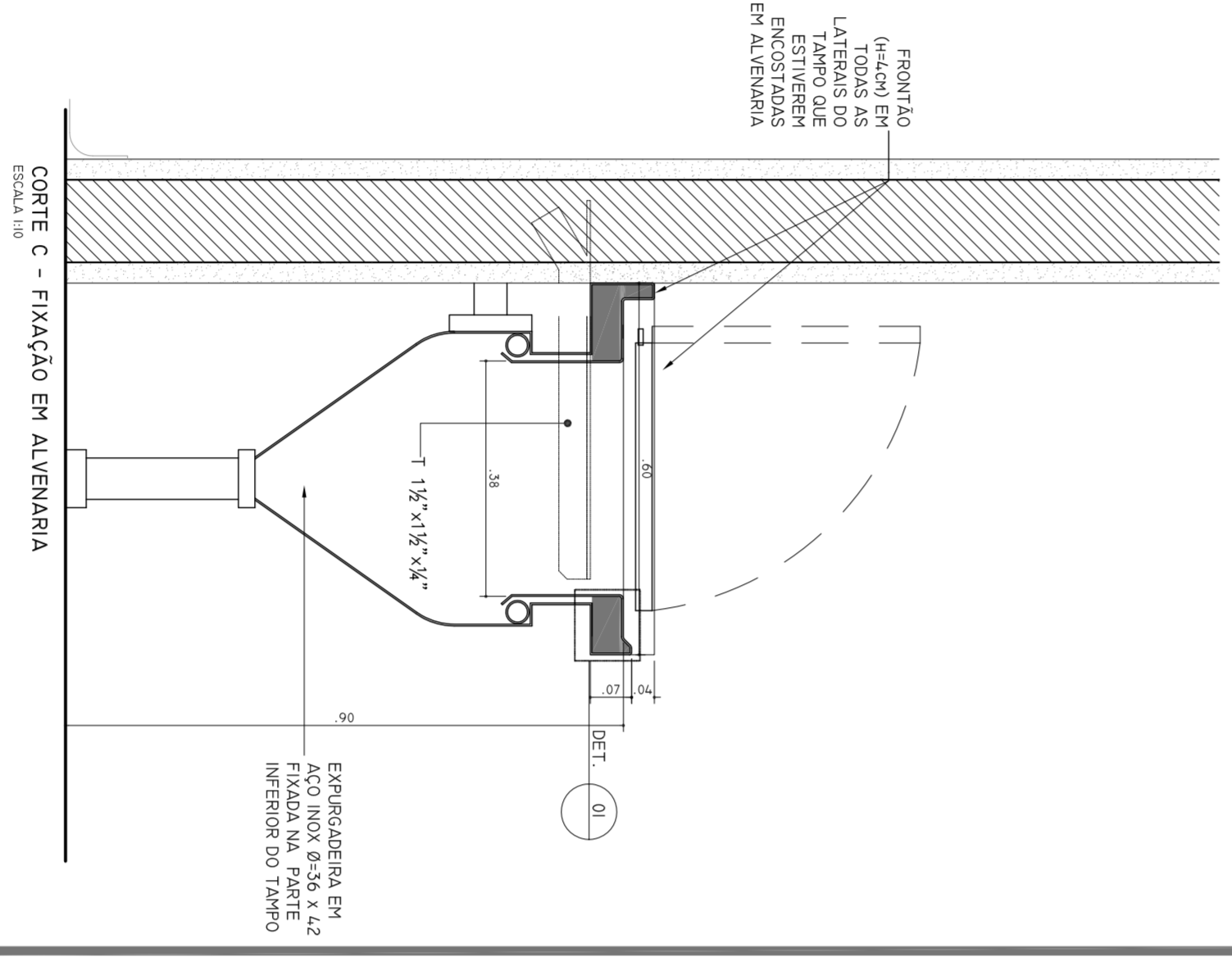

CORTE D - BANDEJA DE INOX

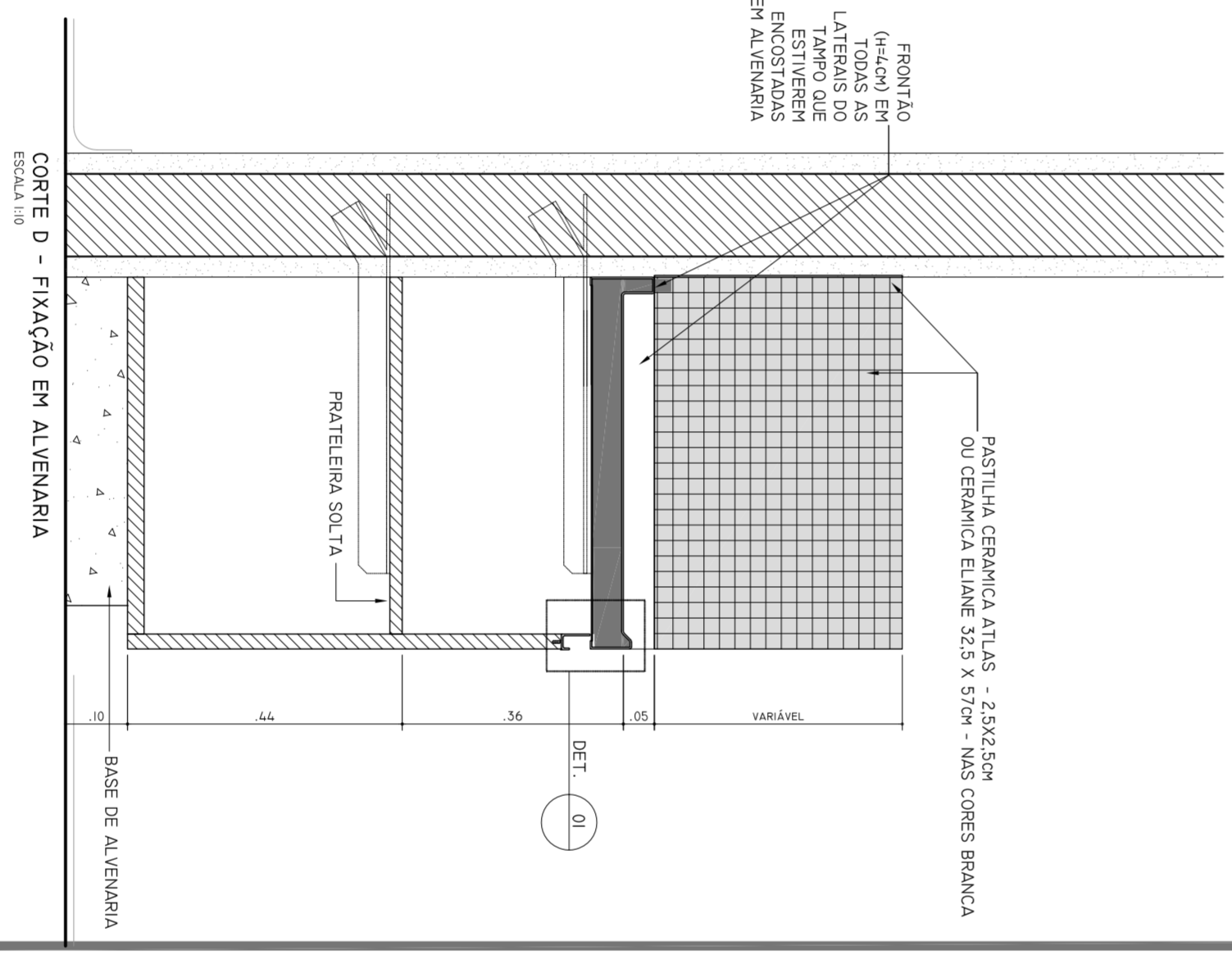

CORTE E - BANDEJA DE INOX COM CABA RASA (SIMPLES)

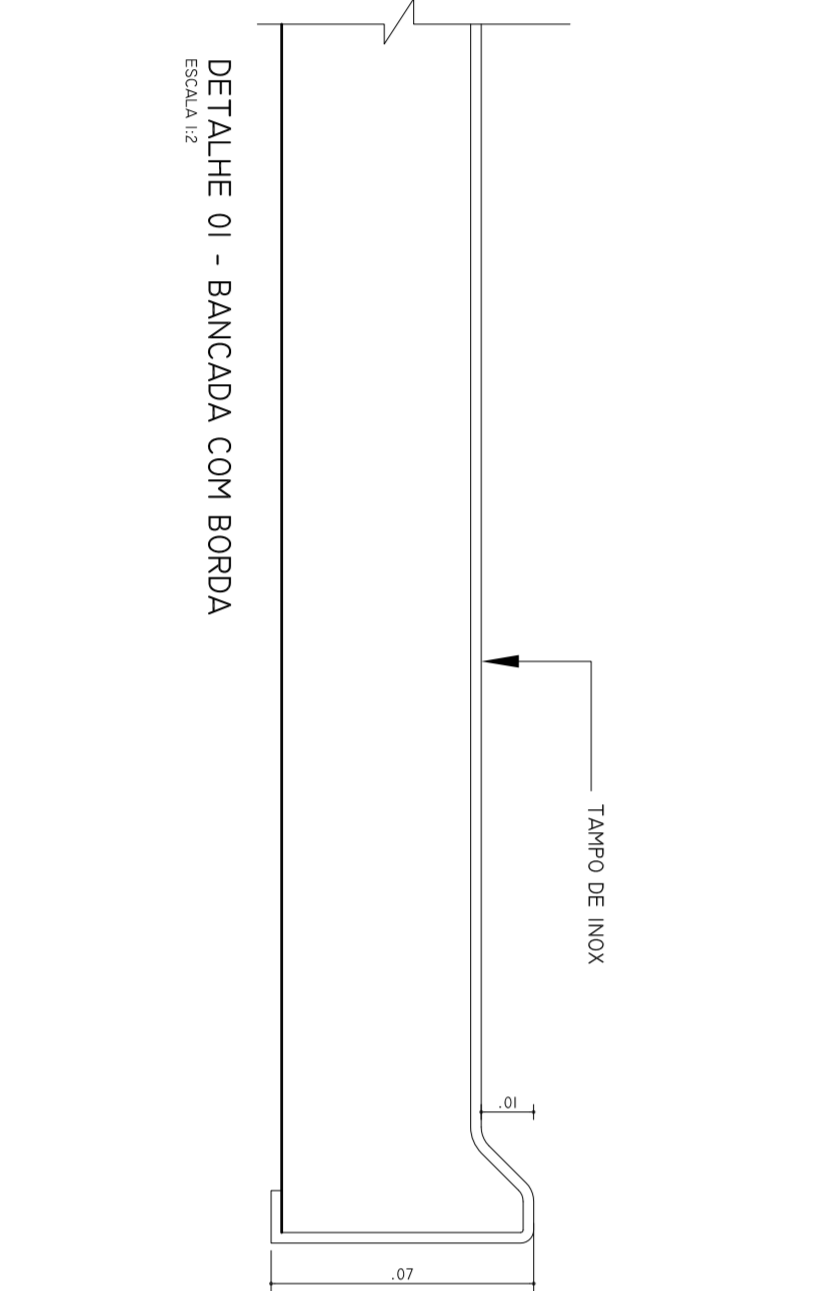
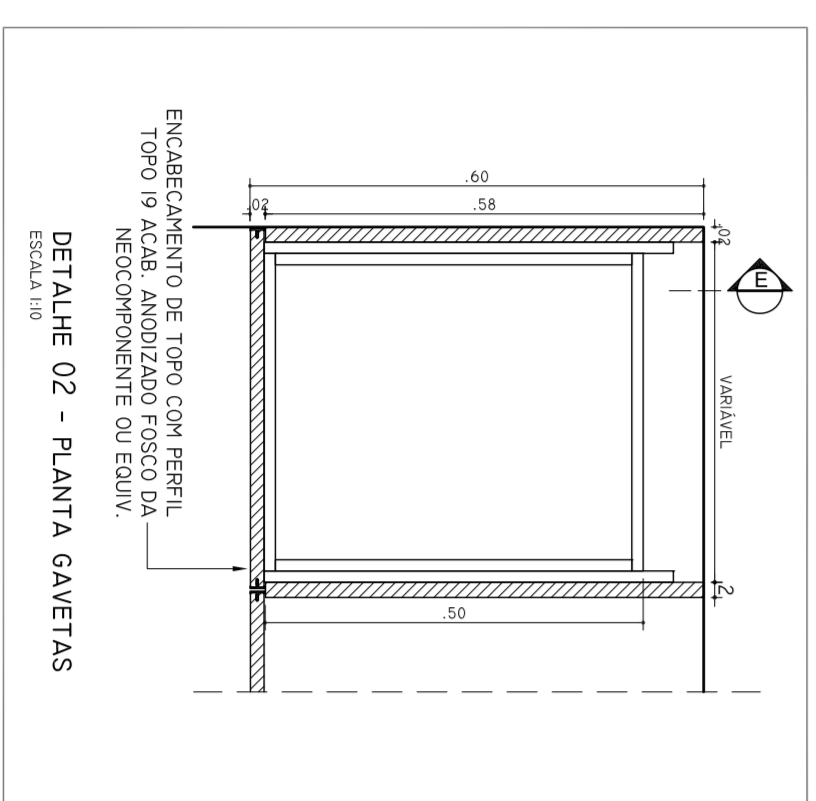
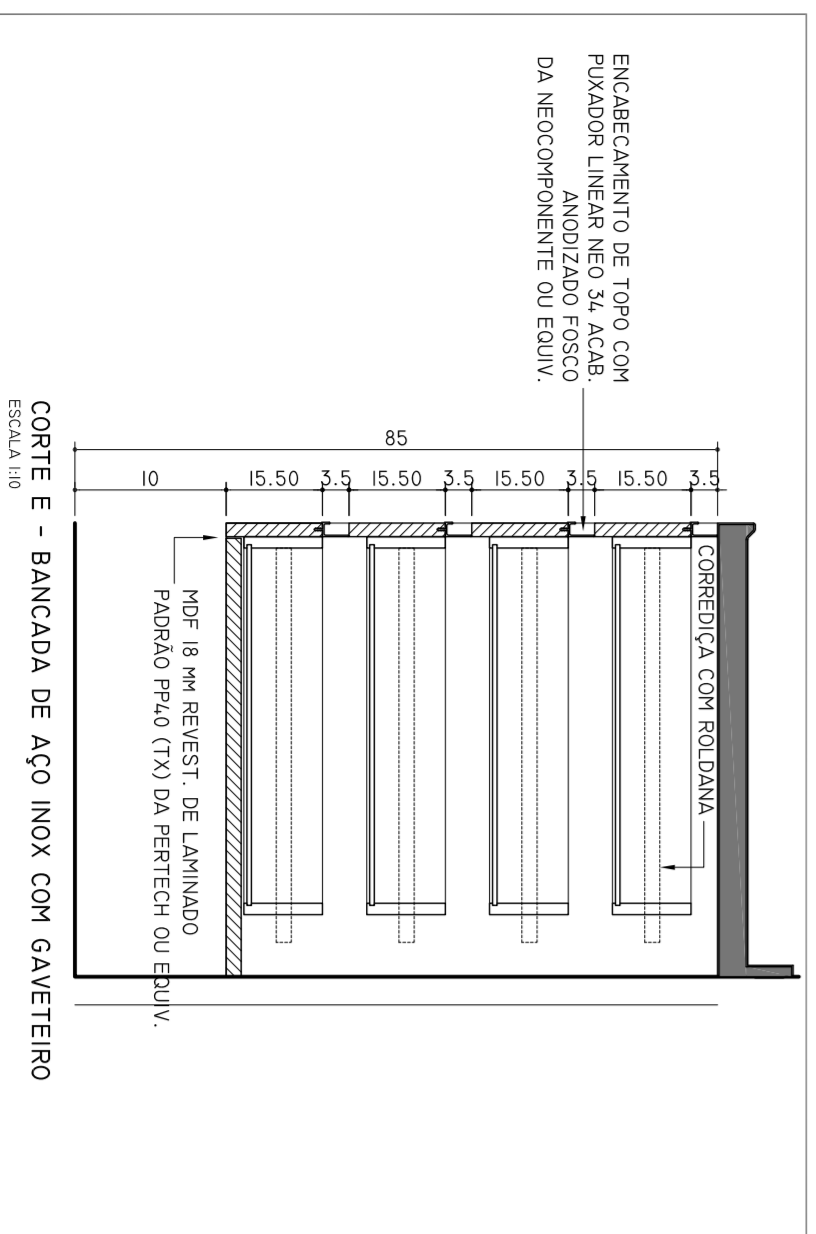
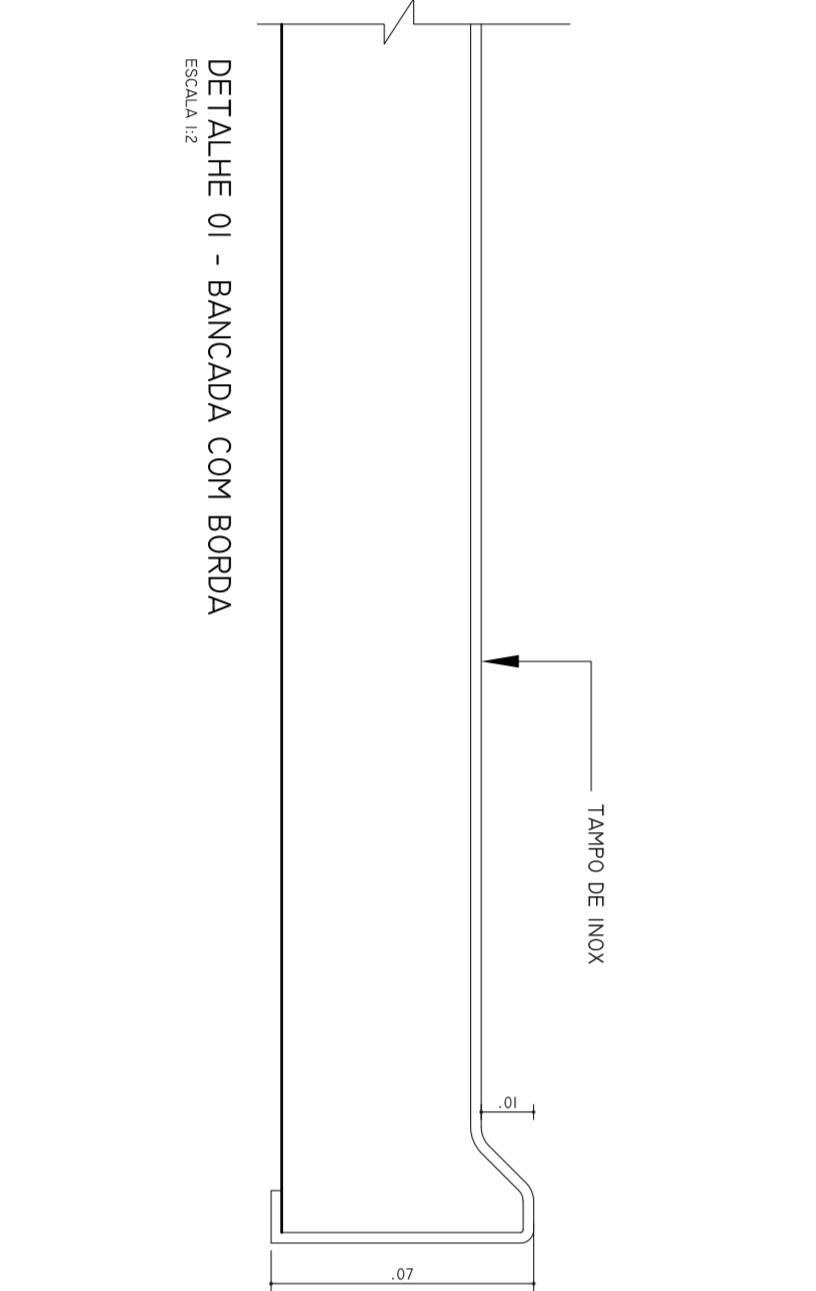
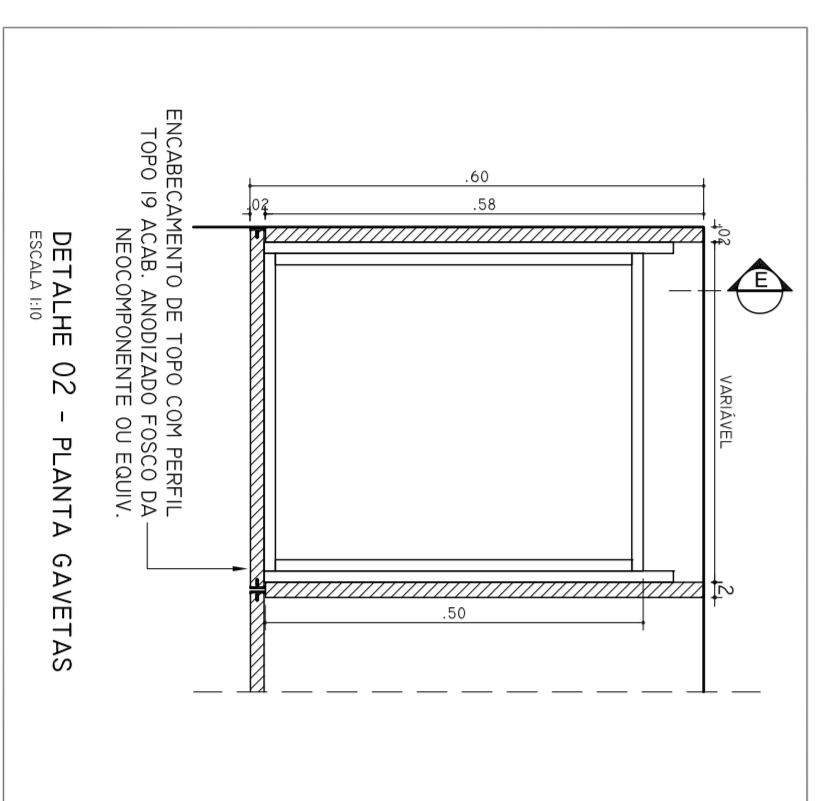
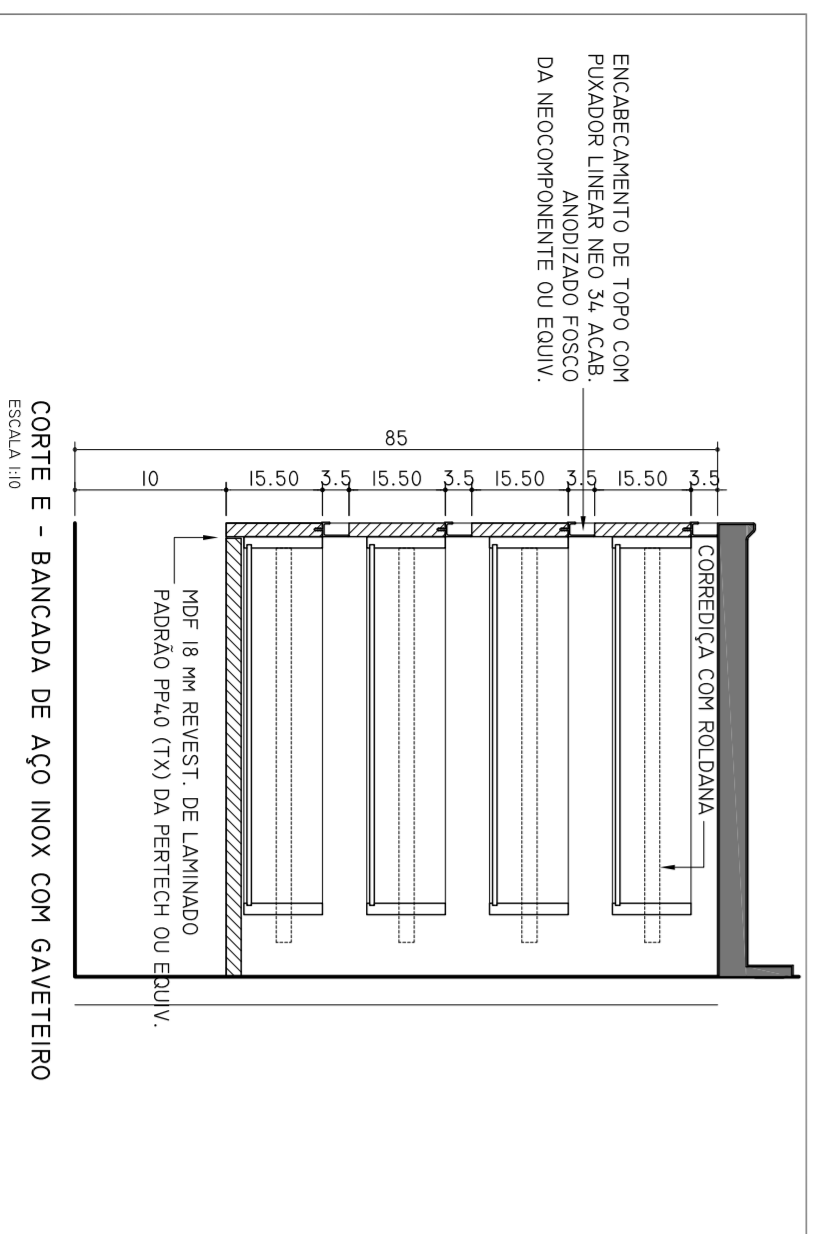
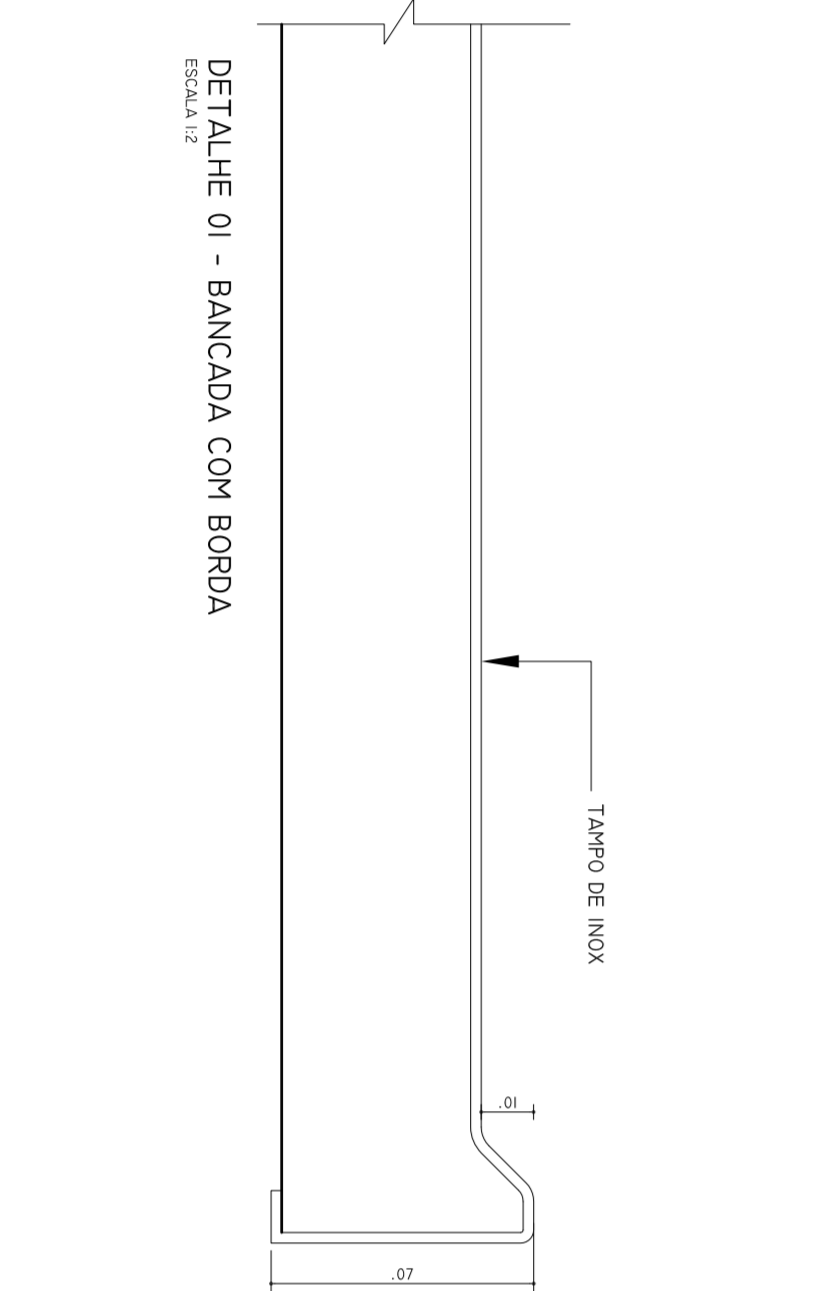
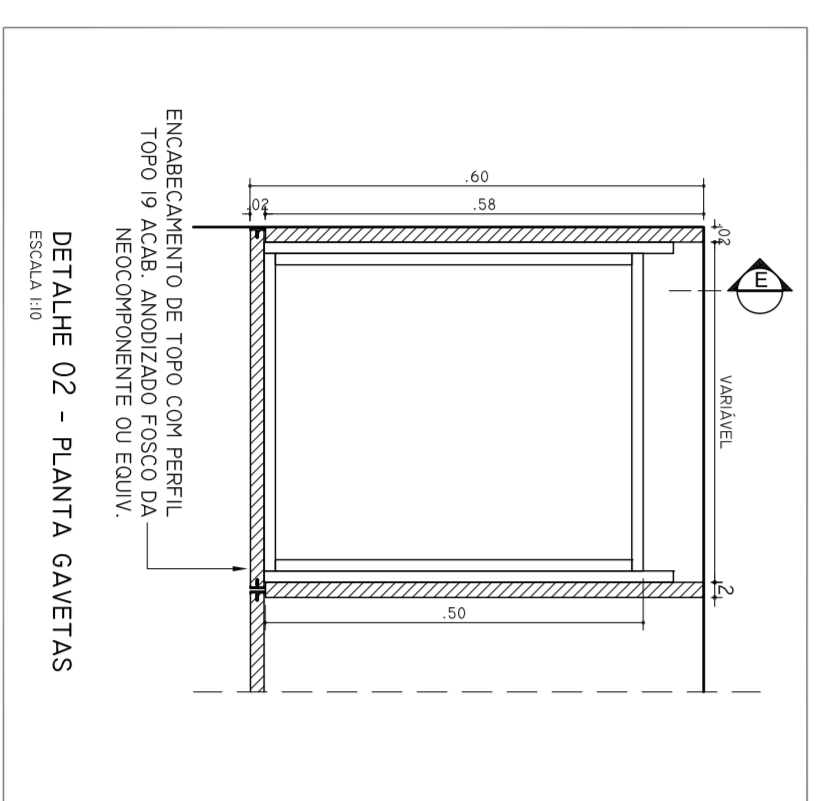
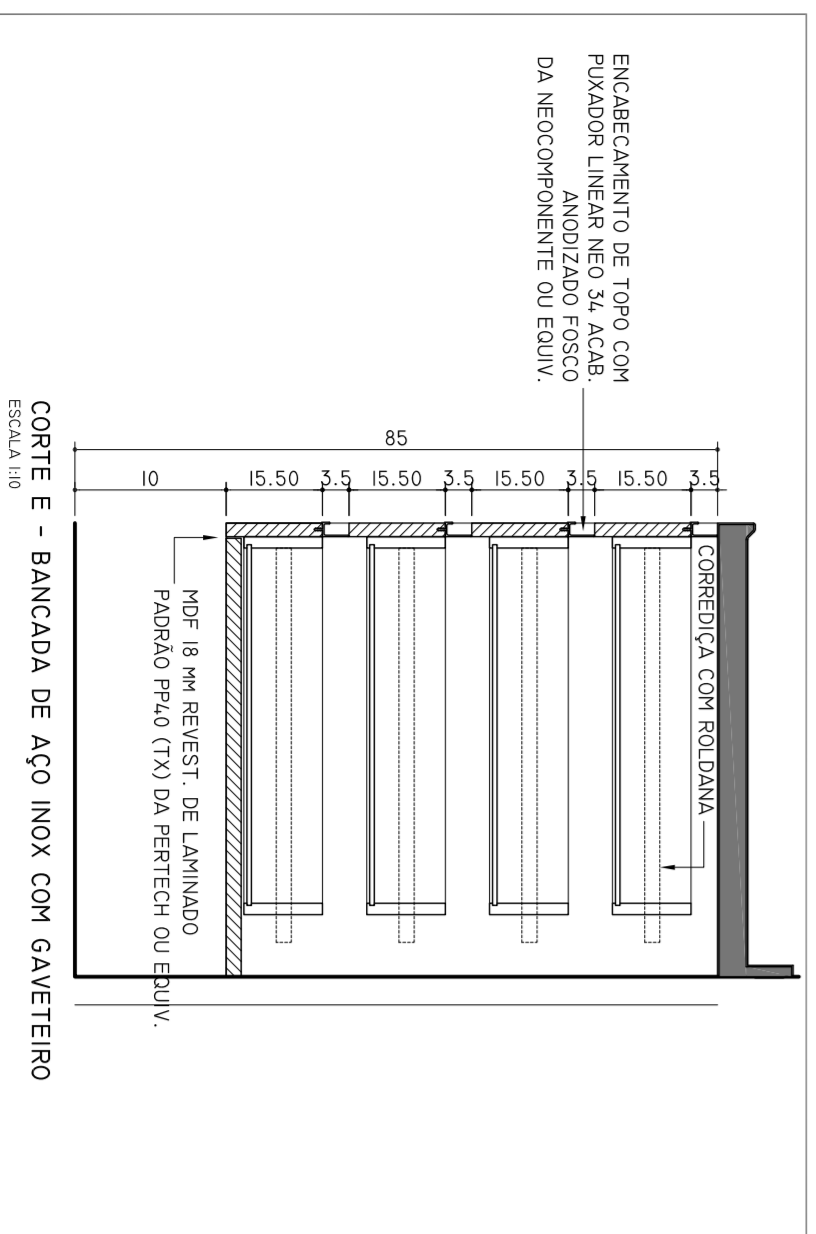
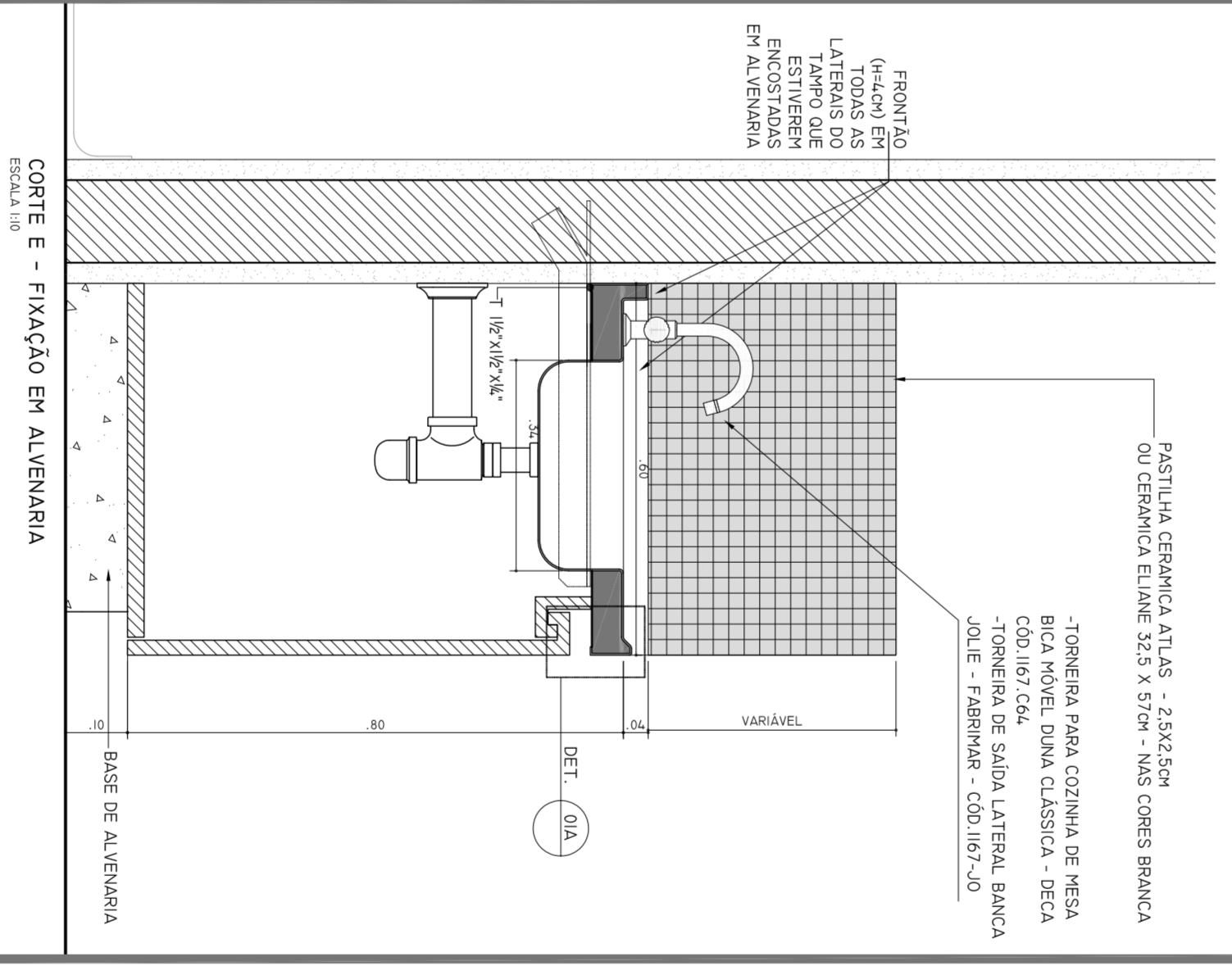

NOTAS

1. CONFERIR MEDIDAS NO LOCAL
2. MEDIDAS EM METRO, EXCETO ONDE INDICADO
3. DIMENSÕES EM MILÍMETROS
4. DIMENSÕES EM CENTÍMETROS
5. DIMENSÕES EM DECÍMETROS
6. DIMENSÕES EM METROS
7. DIMENSÕES EM KILOMETROS
8. DIMENSÕES EM HECTOMETROS
9. DIMENSÕES EM METEROS
10. DIMENSÕES EM DECAHETEROS

SECRETARIA DE ESTADO DA SAÚDE - SUS/SP
 INSTITUTO DE METEOROLOGIA EMILIO RIBAS
 GRUPO TÉCNICO DE EDIFICAÇÕES
 DETALHES GERAIS - PAVILÃO RIBAS
 PROJETO EXECUTIVO
 HOS-902
 08/2014

valdeci fernandes
 arquiteto responsável

PROJETO EXECUTIVO
 HOS-902
 08/2014

PROJETO EXECUTIVO
 HOS-902
 08/2014